

PROPANE CHILLER PROJECT

EcoPack 

 **ELETROFRIO**
REFRIGERAÇÃO

IN PARTNERSHIP WITH



ORGANIZAÇÃO DAS NAÇÕES UNIDAS
PARA O DESENVOLVIMENTO INDUSTRIAL

MINISTÉRIO DO
MEIO AMBIENTE



PÁTRIA AMADA
BRASIL
GOVERNO FEDERAL

R-290



R-290

**PROPANE
YOU NEED TO HAVE
KNOWLEDGE, PROCEDURE AND RESPECT**

✓ **MONTREAL PROTOCOL**

✓ **KIGALI AMENDMENT**

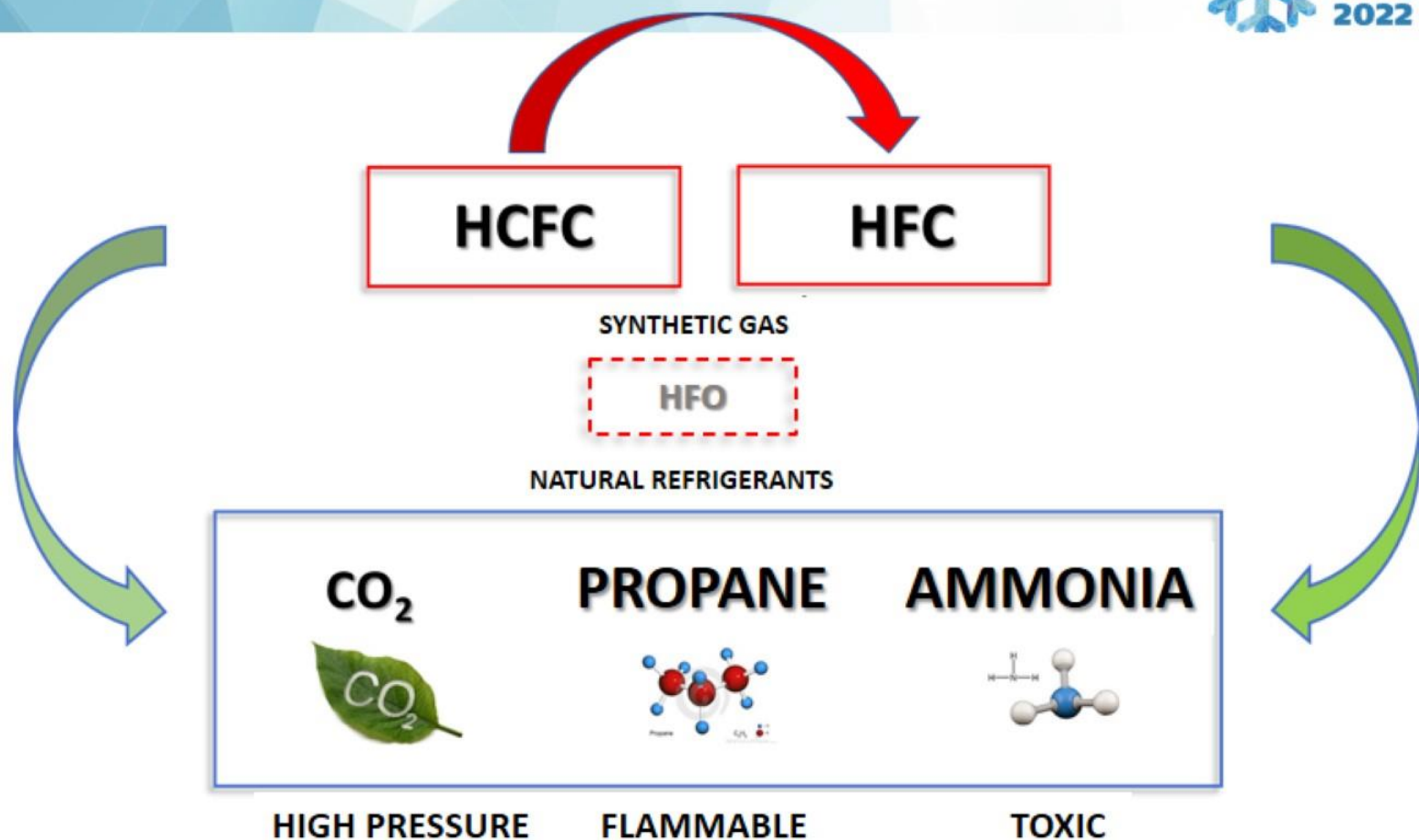

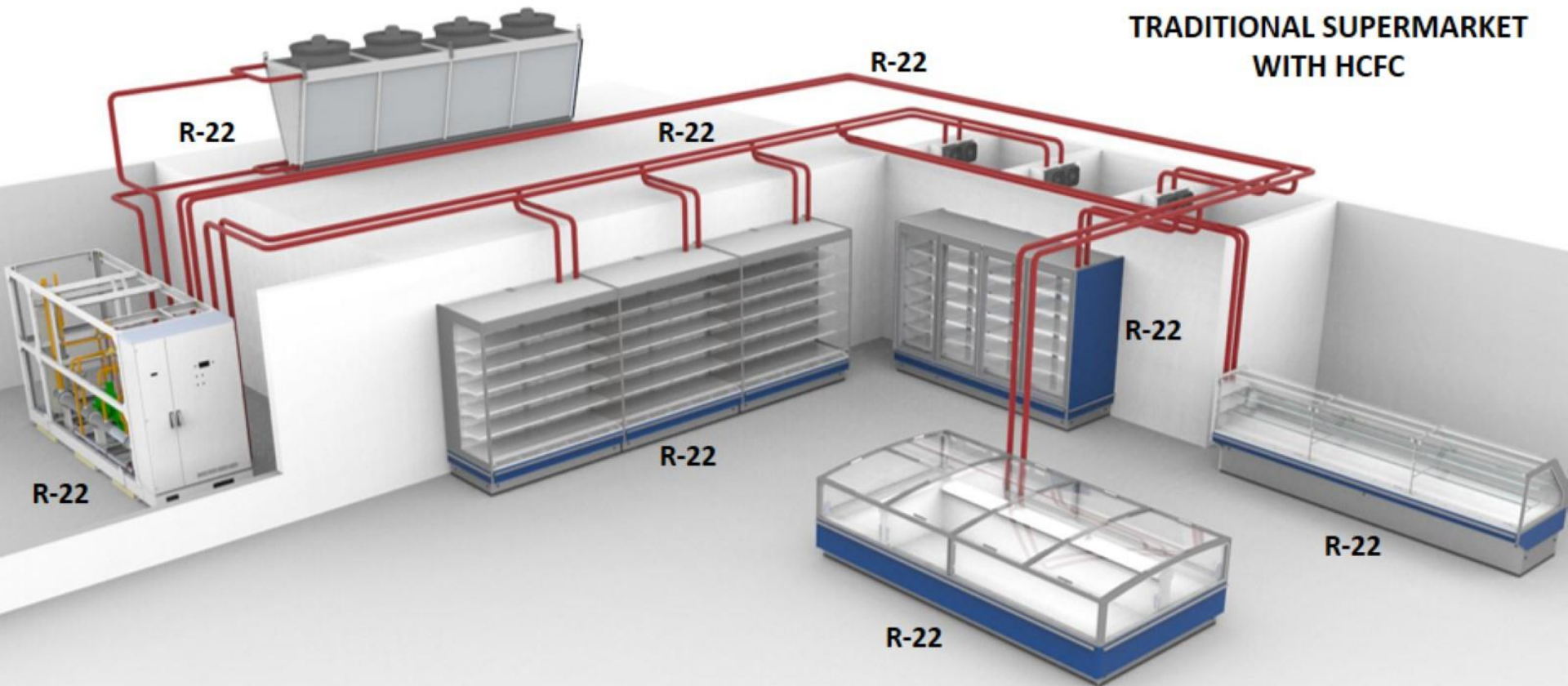

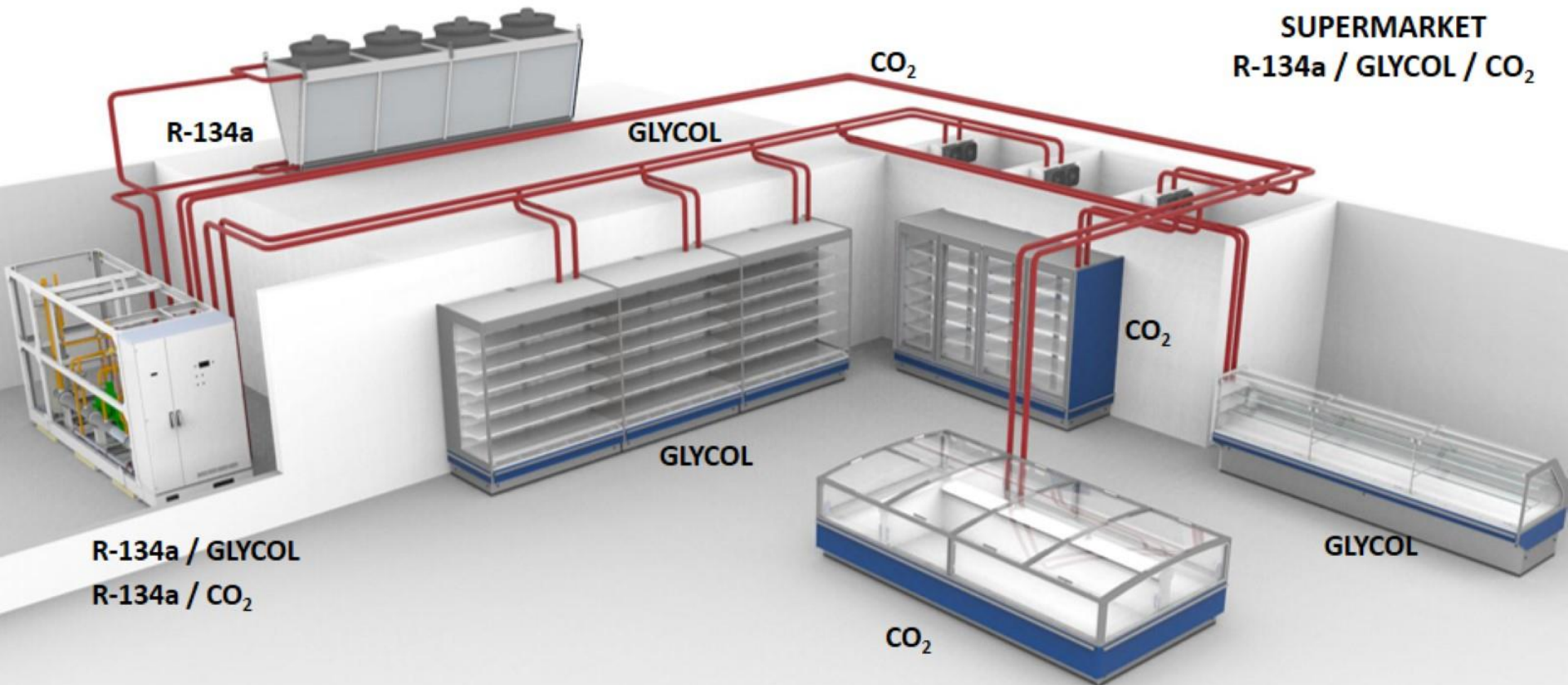

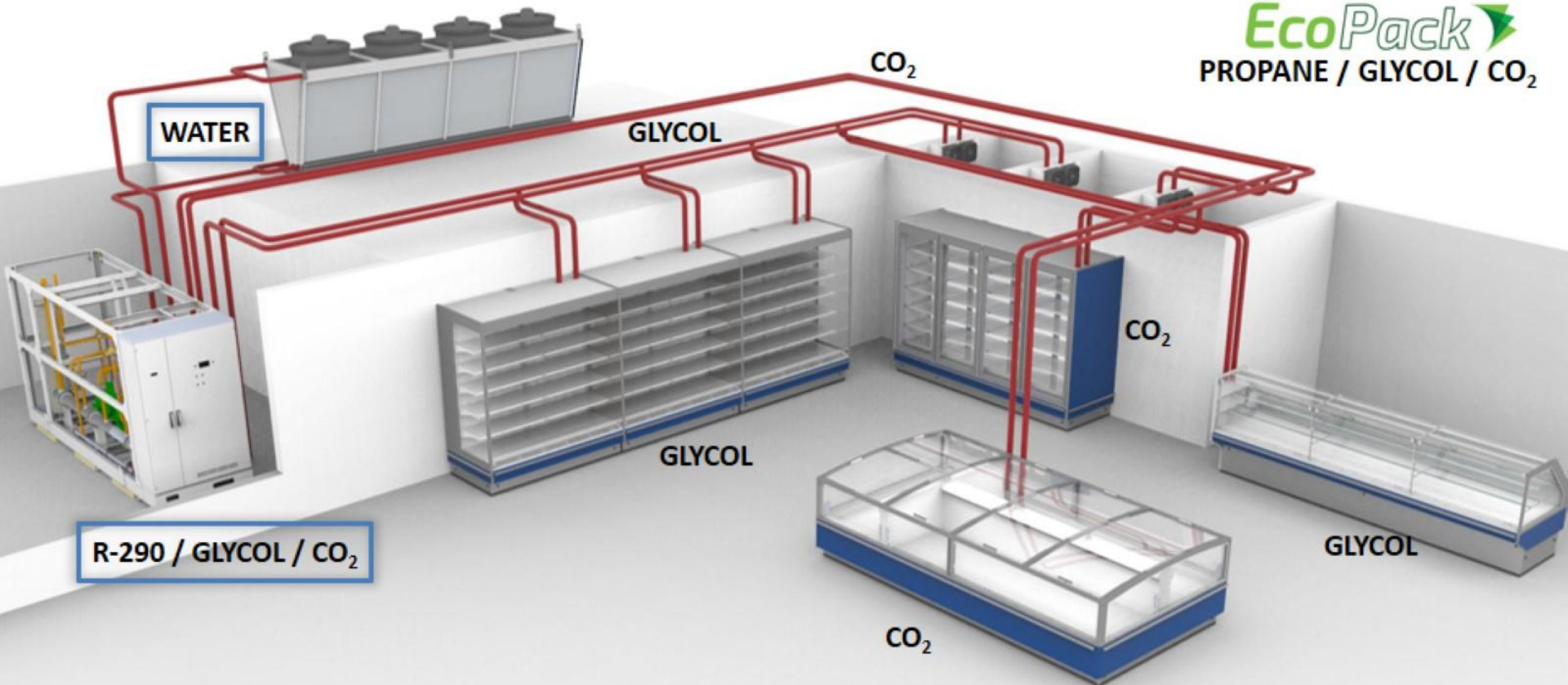

**BENCHMARKING
EUROPE / UNITED STATES**



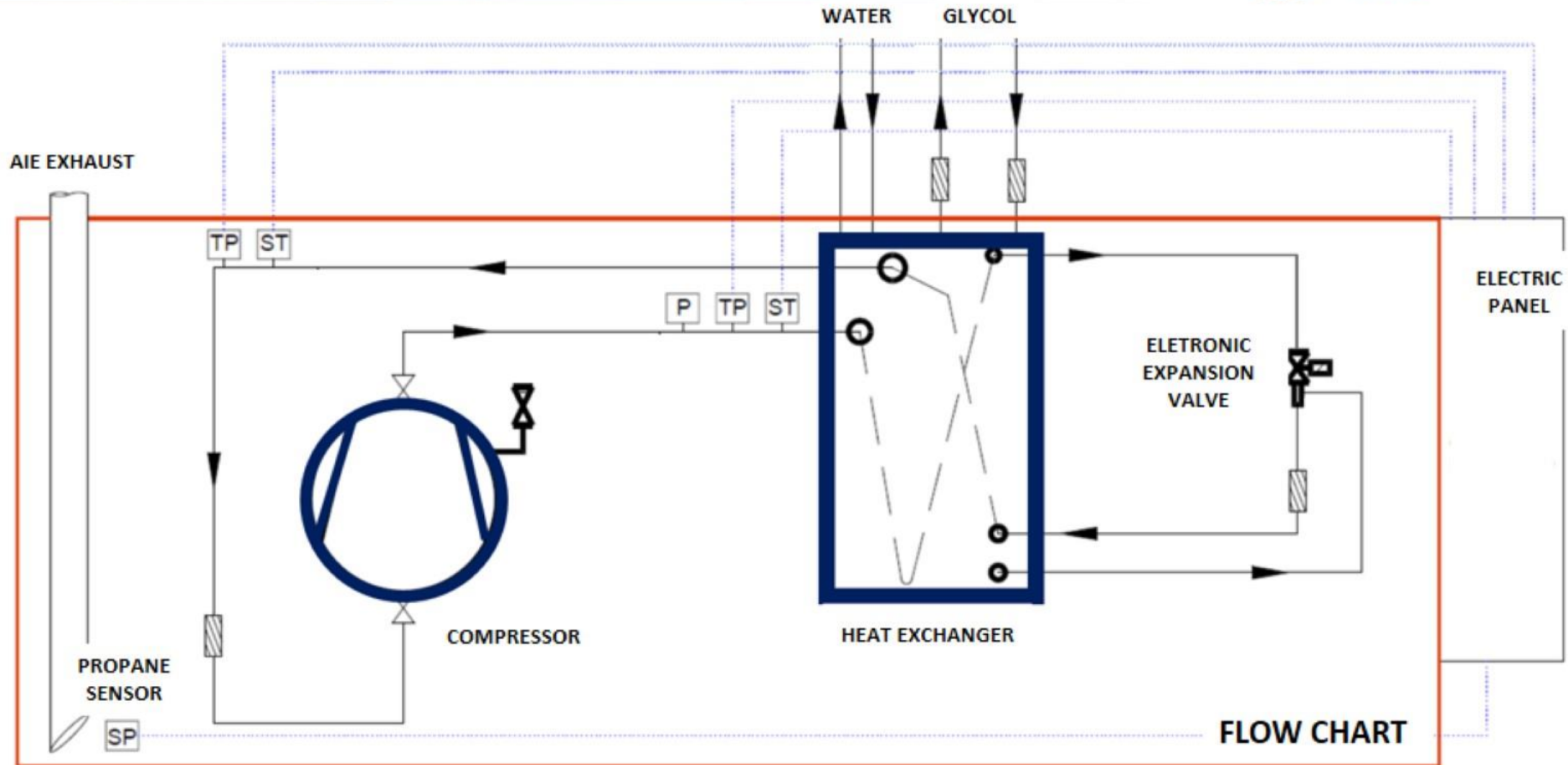

EVAPORATION TEMPERATURE	-7°C
CONDENSATION TEMPERATURE	50°C (Maximum)
GLYCOL OUTLET TEMPERATURE	-3°C
CAPACITY OF MODULE A	20.000 kcal/h
PROPANE CHARGE MODULE A	1,90 kg

AIE EXHAUST

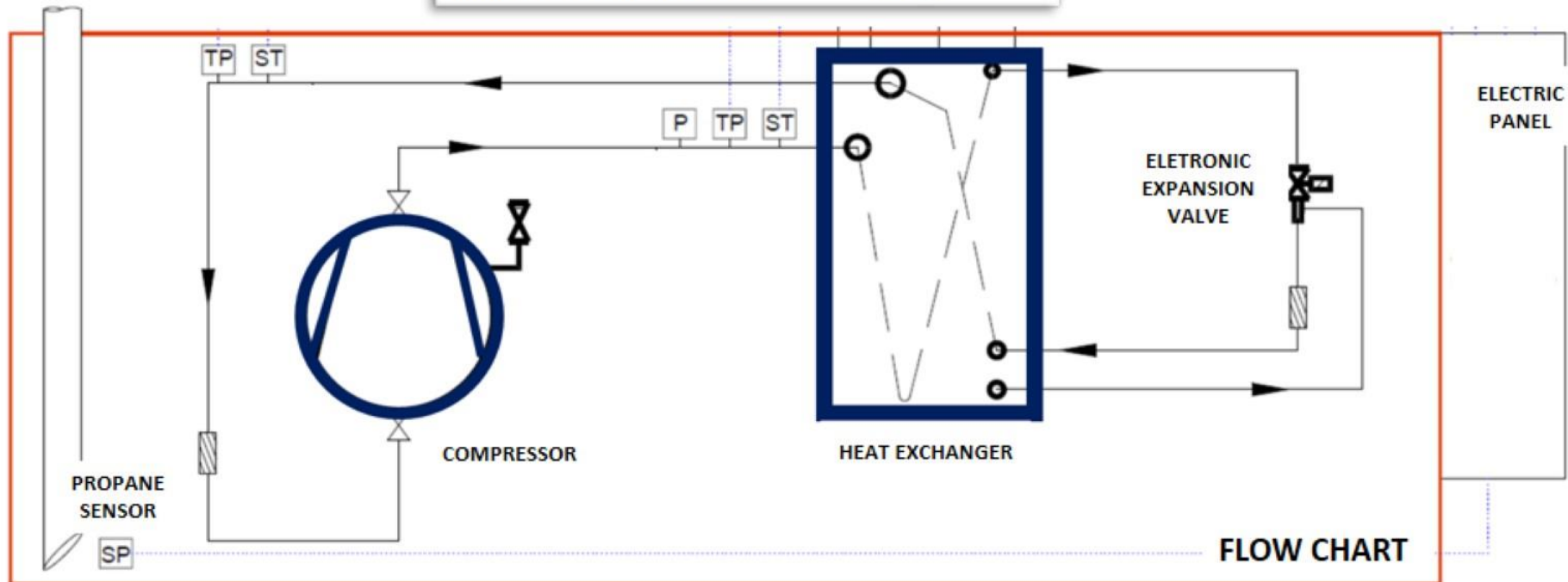

CONTROL ZONE: ATEX definition for zone 2 > Location where an explosive atmosphere consists of a mixture with air of flammable substances in the form of gas, steam or mist, they are not likely to occur under normal conditions, but, if they do, only for a short period.

**CONTROL ZONE
BOUNDARIES**

AIE EXHAUST

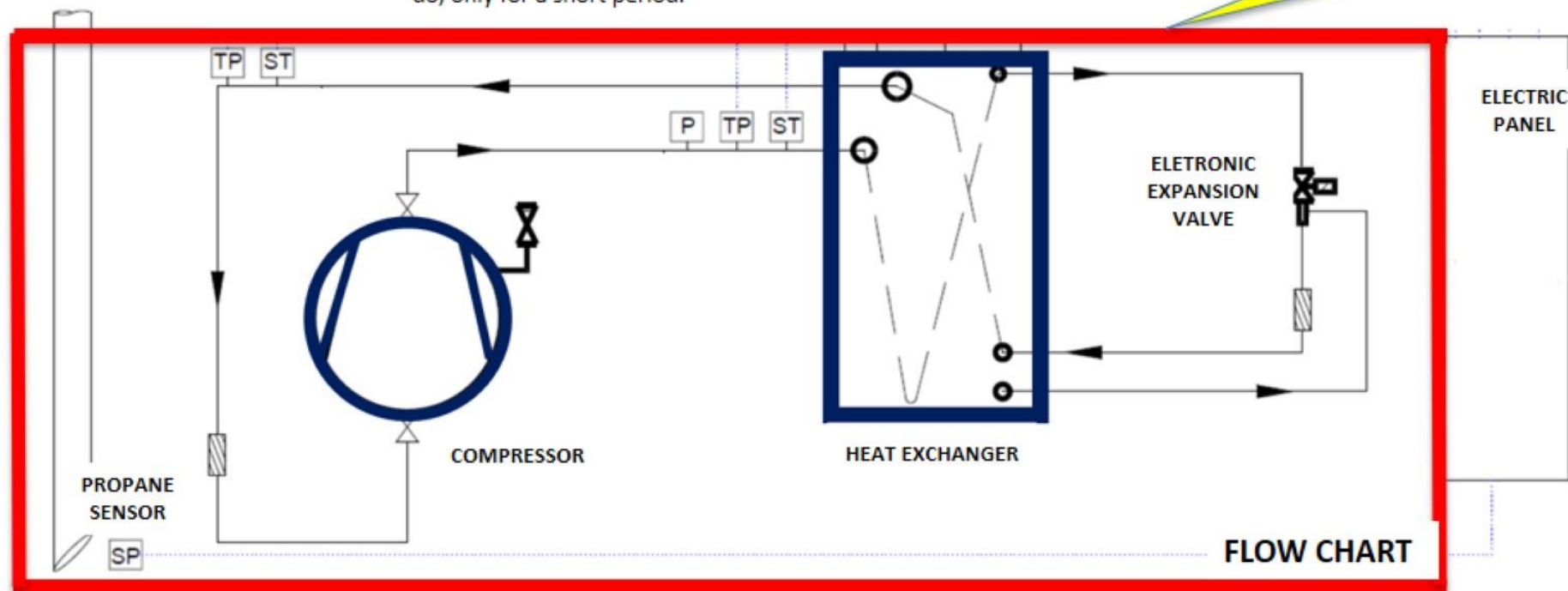

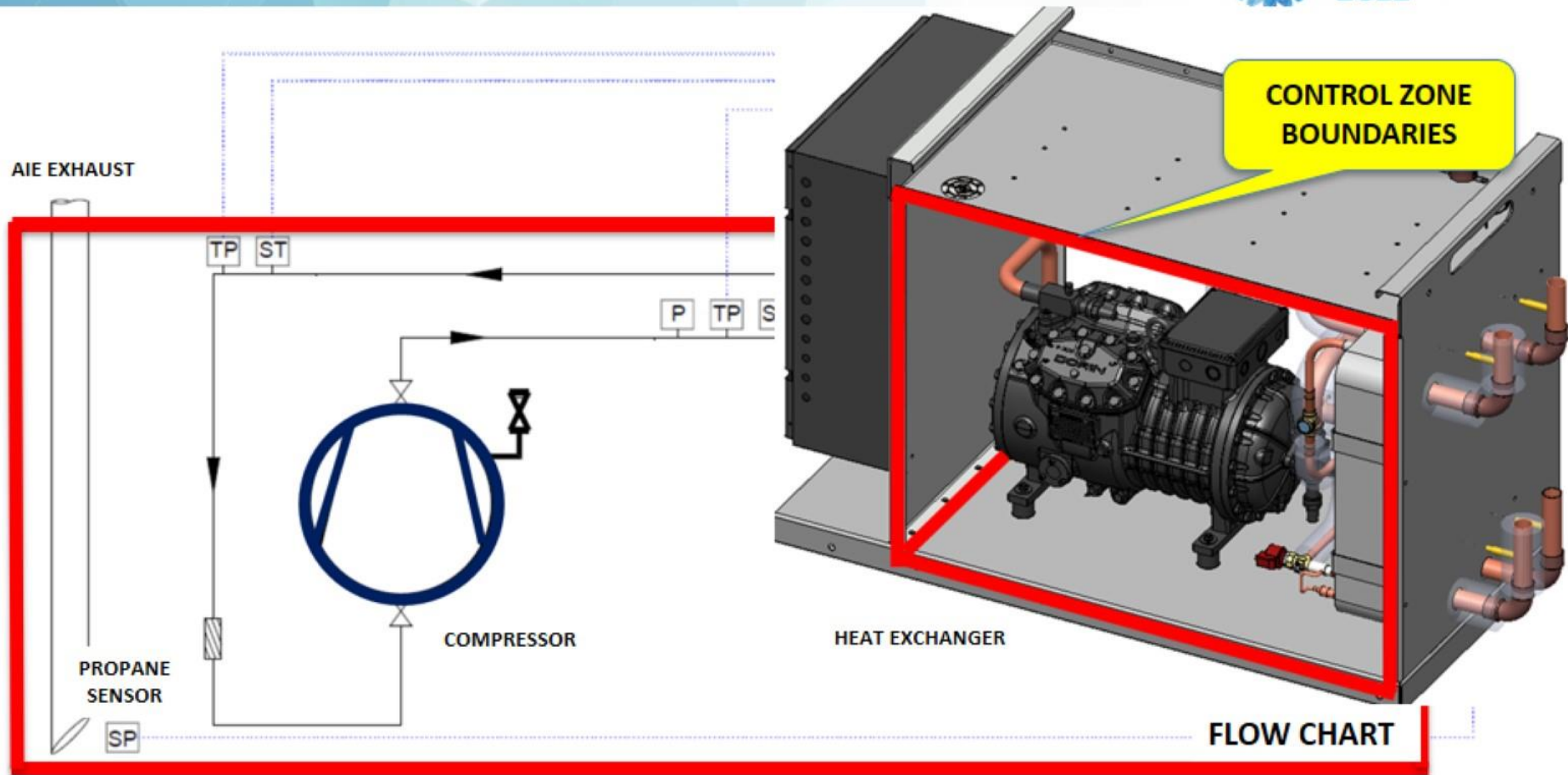

**DEMONSTRATION
PROJECT
APRIL 2019**



SUPERMERCADO CONDOR
Curitiba - PR Brazil



**DEMONSTRATION
PROJECT
APRIL 2019**

Condor

**SUPERMERCADO CONDOR
Curitiba - PR Brazil**



**DEMONSTRATION
PROJECT**
APRIL 2019



SUPERMERCADO CONDOR
Curitiba - PR Brazil



**DEMONSTRATION
PROJECT
APRIL 2019**



SUPERMERCADO CONDOR
Curitiba - PR Brazil



DEMONSTRATION
PROJECT
APRIL 2019



SUPERMERCADO CONDOR
Curitiba - PR Brazil



LOW TEMPERATURE
R-290 (SELF-CONTAINED)

LOW TEMPERATURE
CO₂

- ✓ **8 SUPERMARKETS IN OPERATION**
- ✓ **1 IN ASSEMBLING**



THANK YOU FOR YOUR ATTENTION



ROGÉRIO MARSON RODRIGUES
ENGINEERING MANAGER

CURITIBA - PR BRAZIL

+55 41 99971-0116

marson@eletrofrio.com.br